



**Crown XCL
HPL dosky
pre vonkajšie použitie**







Elegancia
sa stretavá
s trvanlivosťou.



Crown Laminate je inovatívnym a všestranným riešením pre fasádne obklady, ktoré zlepšujú vzhľad, výkonnosť a dlhú životnosť každého objektu.

Dosky HPL CrownXCL sa vyrábajú v termosetovom lise pri vysokej teplote a tlaku. Pridanie dvakrát vytvrdených akrylových PUR živíc ďalej zvyšuje trvanlivosť panelov. V dôsledku toho je CrownXCL extrémne odolný a

účinne chráni pred klimatickými vplyvmi a UV žiarením. CrownXCL plní severoamerické požiarne štandardy a je odolný proti nárazu aj poškrabaniu. Táto odolnosť umožňuje aplikáciu CrownXCL v rôznych exteriéroch,

ako sú fasádne obklady, balkóny, exteriérový nábytok, stropy, ploty a ďalšie. Panely CrownXCL sa ľahko montujú, inštalujú a udržujú a ponúkajú širokú škálu dizajnových možností.



Ohňovzdorný



Lahká inštalácia



Jednoduché čistenie



Odoláva nárazom



Vytvrdzovaný



Anti-graffiti



Vrátane UV ochrany



Nepremokavé a odolné voči vode



Odolné proti poškrabaniu



Zlepšuje zvukovú izoláciu



CrownXCL Oplotenie

Vďaka prakticky neobmedzeným možnostiam dizajnu môžete využiť svoju predstavivosť k vytvoreniu plotu, ktorý je architektonicky príjemný a zachová si svoju pôvodnú krásu po mnoho ďalších rokov.



CrownXCL: ohľaduplnosť k životnému prostrediu

Papier používaný k výrobe CrownXCL je vyrobený zo surovín pochádzajúcich z udržateľných lesov.

Naše panely sú vyrobené z 80% z celulóзовých vlákien získaných z udržateľných zdrojov a z 20% z termosetových živíc. CrownXCL neobsahuje žiadne ťažké kovy ani azbest. Neemitujú tiež žiadne plyny, výpary, rozpúšťadlá alebo kvapaliny. Výsledkom je, že panely CrownXCL nemajú negatívny vplyv na znečistenie životného prostredia. Panely CrownXCL boli nezávisle testované a sú v súlade s niekoľkými environmentálnymi certifikáciami vrátane certifikácie Greenguard Gold a certifikácie Intertek Green Leaf.



Exteriér

ROZMERY *

A 1220 x 2440 mm

B 1220 x 3050 mm

C 1300 x 3050 mm

HRÚBKA *

6, 8, 10, alebo 13 mm

DEKOR

Obojstranný

POVRCH

Polomatný s jemnou štruktúrou

Pozn.: Povrchy podľa požiadavky na dopyt.

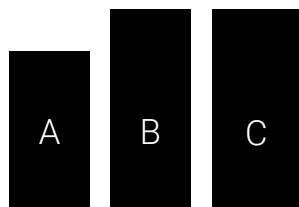

6 mm

8 mm

10 mm

13 mm

* Nominálne



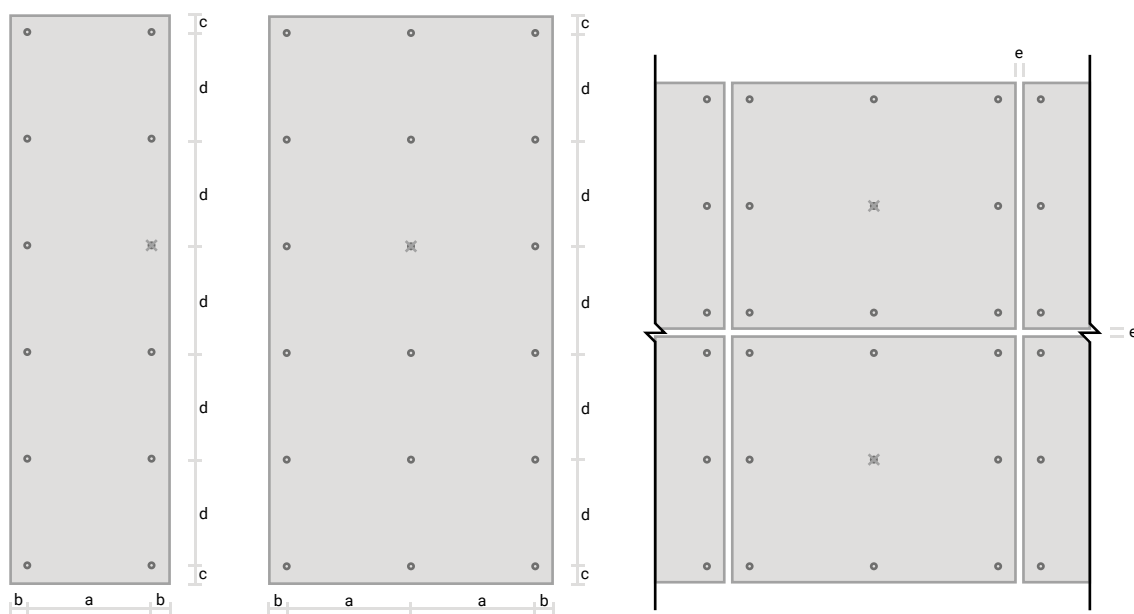

✕ Predstavuje pevný bod.

Vyššie uvedené schémy ukazujú optimálny priestor medzi spojovacími prvkami a okrajom panelu. Zobrazujú sa aj optimálne rozstupy medzi jednotlivými panelmi. Jedná sa o jedno riešenie, ktoré je možné v závislosti od projektu vhodne zmeniť.

Hrúbka*	Maximálny rozstup skrutiek(a) *	Minimálna vzdialenosť od hrany (b, c) *	Maximálny rozstup skrutiek(d) *	Dilatačná medzera (e) *
6 mm	450 mm	50, 20 mm	550 mm	6-10 mm
8 mm	600 mm	50, 20 mm	750 mm	6-10 mm
10 mm	750 mm	50, 20 mm	900 mm	6-10 mm

* Nominálne

Technické parametre



Vlastnosti

Parameter	Štandardná hodnota	Hodnota CrownXCL
Hustota	1.35 g/cm ³	1.45 g/cm ³
Pevnosť v ohybe	80 N/mm ²	114 N/mm ²
Modul pružnosti	9000 N/mm ²	13966 N/mm ²
Pevnosť v ťahu	60 N/mm ²	66 N/mm ²
Rozmerová stabilita pri zvýšenej teplote	Po dĺžke: 0,40% Priečne: 0,80%	Po dĺžke: 0,25% Priečne: 0,40%
Umelé zvetrávanie	Sivá stupnica: hodnota 3 Vzhľad: hodnota 4	Sivá stupnica: hodnota 4 Vzhľad: hodnota 4
Odolnosť proti UV žiareniu	Sivá stupnica: hodnota 3 Vzhľad: hodnota 4	Sivá stupnica: hodnota 4 Vzhľad: hodnota 4

Požiarne správanie

Platné v	Testovacia metóda	CrownXCL
Kanada	CAN/ULC S134	Vyhovuje
Európa	CSN EN 13501-1+A1	B-s1, d0 (Vyhovuje)
USA	NFPA 285	Splňuje
Kanada + USA	ASTM E 84	Index šírenia plameňa: 10 Tvorba dymu: 0

Pre kompletný zoznam skúšok a certifikácií nás prosím kontaktujte.

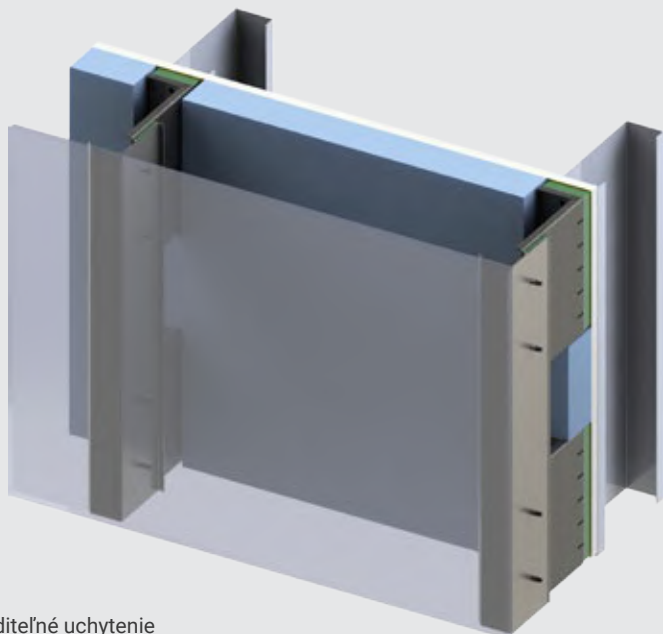

Viditeľné uchytenie

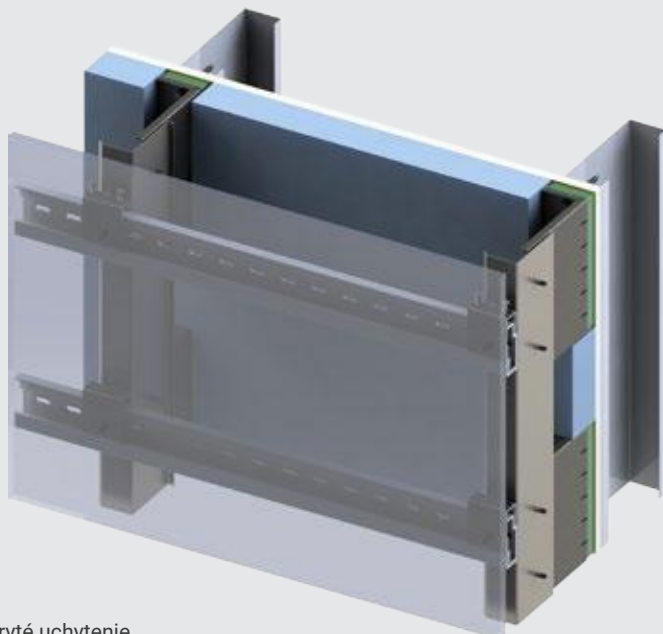

Skryté uchytenie

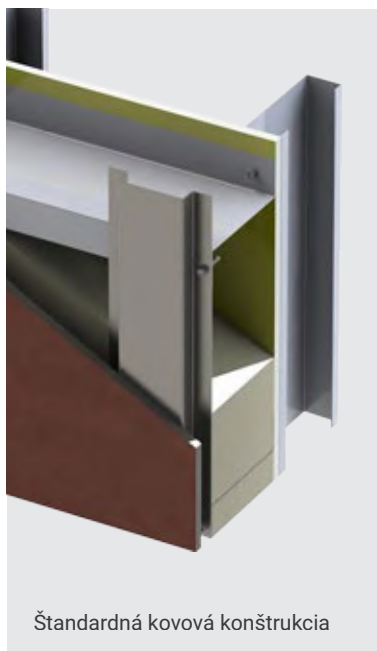

Štandardná kovová konštrukcia

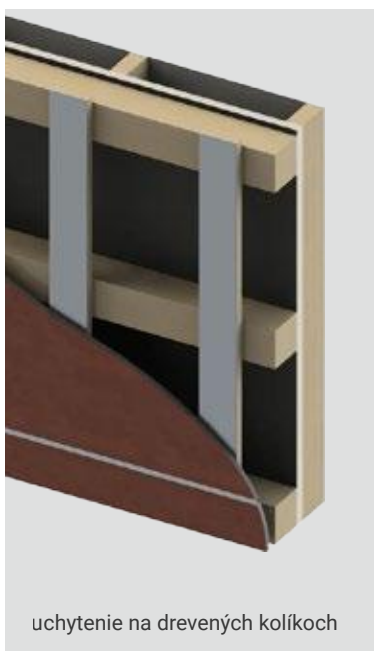

uchytenie na drevených kolíkoch

MOŽNOSTI VYUŽITIA V OBLASTI FASÁD

Rozmanité využitie panelov CrownXCL zahŕňa ako odvetrané fasády, tak aj fasády konvenčné. Fasády realizované s využitím CrownXCL poskytujú vysoký tepelný štandard a to ako v lete, tak aj v zime, spolu s veľmi dlhou životnosťou, najmä kvôli eliminácii tvorby kondenzátov.

V prípade potreby ďalších informácií o aplikácii alebo záujme o ponuku celého riešenia vrátane realizácie nás, prosím, kontaktujte.

Alternatívne systémy

CrownXCL funguje najlepšie v spojení s odvetranou fasádou, ale je možné použiť aj iné techniky uchytenia. Ďalšie informácie o alternatívnych spôsoboch inštalácie vám radi povieme osobne.

Plné farby

#C851XL	#C856XL	#C13	#C611X
#C17X	#C855XL	#C608X	#860XL
#C10X	#C610XL	#C603XL	#C604XL
#C871XL	#T230	#T229	#C23X
#T221	#T220	#T215	#T235
#T1103	#C864XL	#T1107	#C872XL
#T187	#T218	#T214	#T216
#T201	#C867XL	#T212	#T232
#T217	#T1127	#T227	#C865XL
#T222	#T224	#C869XL	#C609X
#C605X	#T236	#C606X	#C11XL

Ak chcete zistiť dostupnosť, prosím, kontaktujte nás.

Vzhľadom na obmedzenie interpretácie farieb pri tlači nemusí byť reprodukcia presná a pred dokončením výberu farieb sa odporúča vykonať kontrolu fyzickej vzorky.

Textúry



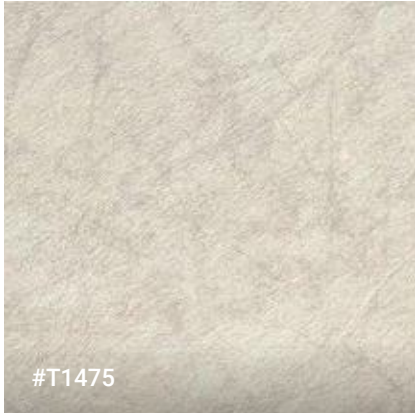

#T1475

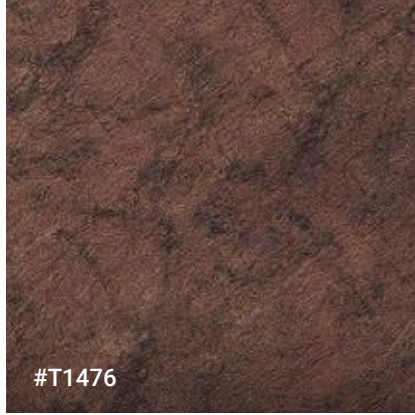

#T1476



#T1477

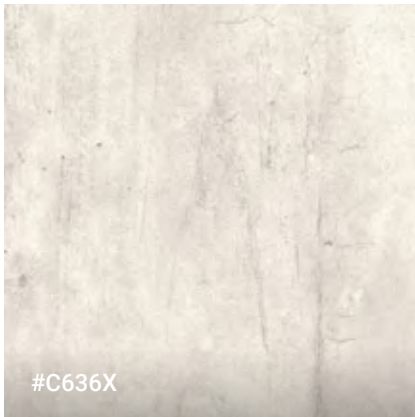

#C636X



#C637X



#T1398



#T1522



#T1523

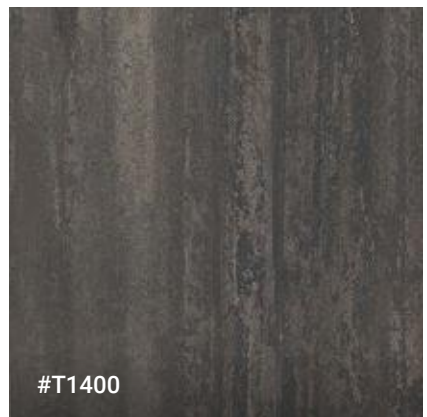

#T1400



#C632X



#C631X



#C633X

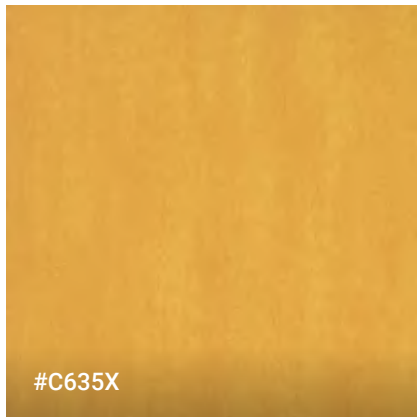

#C635X

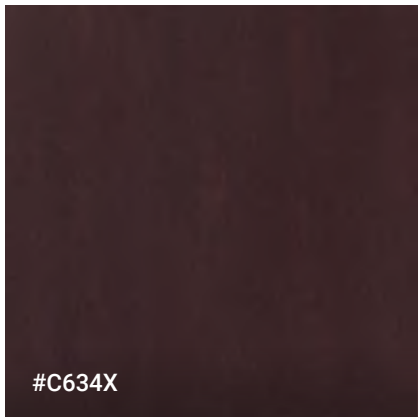

#C634X

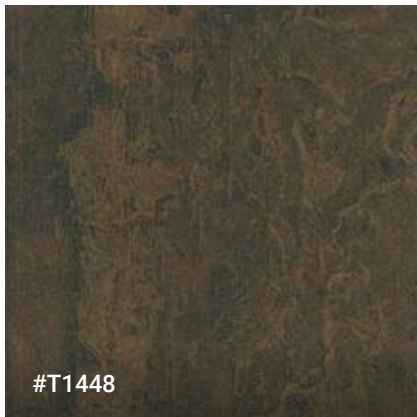

#T1448

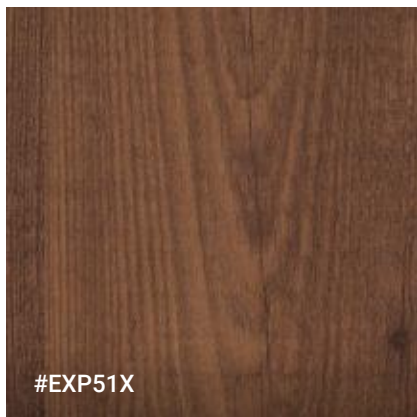

#EXP51X



#EXP55



#C641X



#T1334



#T1335



#T1454

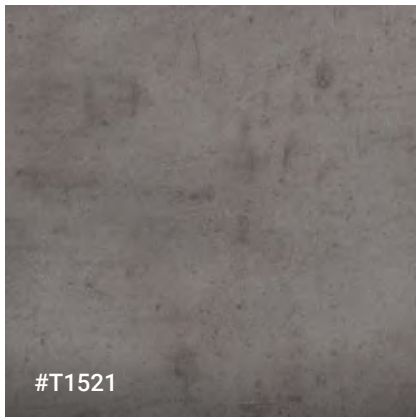

#T1521



#T1520

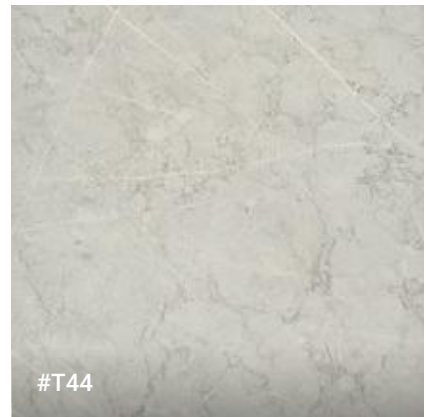

#T44



#T1329



#T1330



#T45

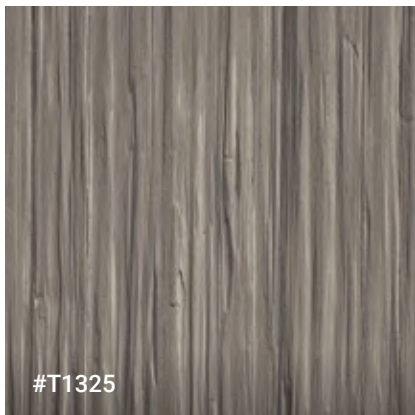
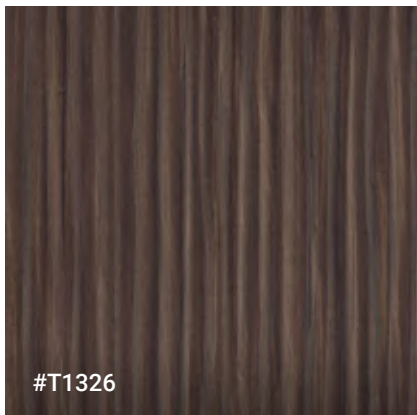
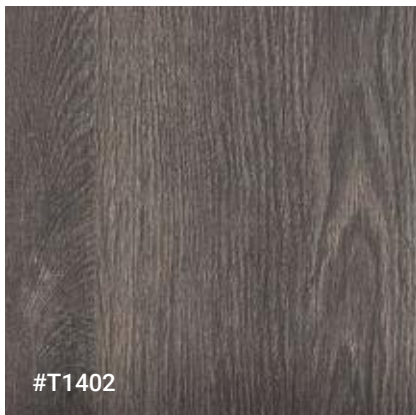
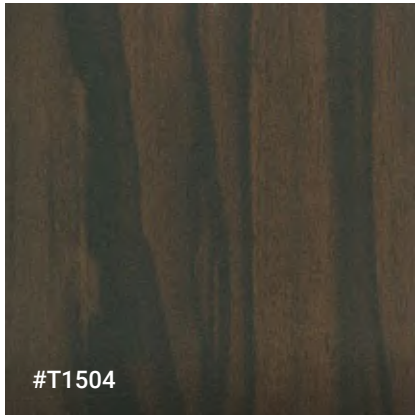
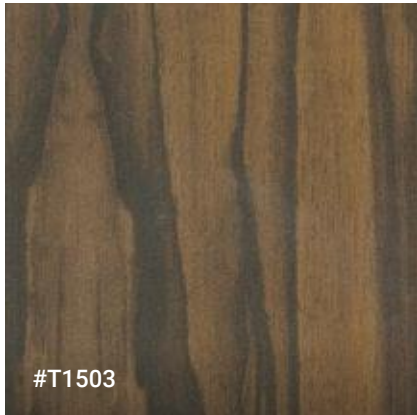
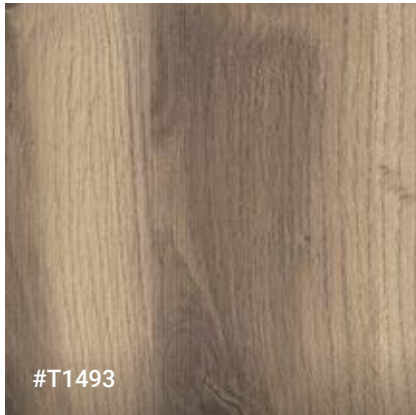
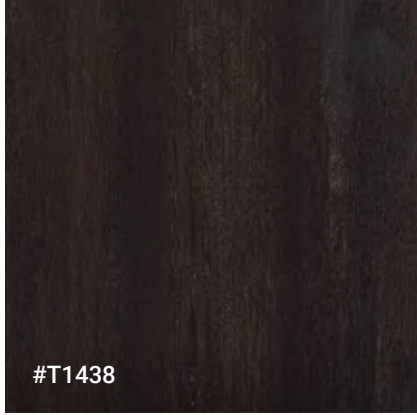



#T61



#T26



#T36

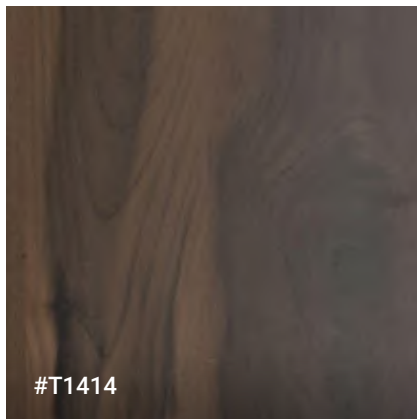

#T1414

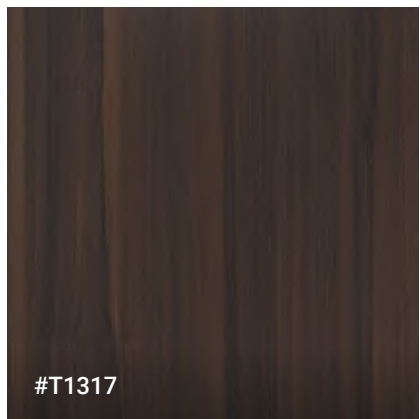

#T1317

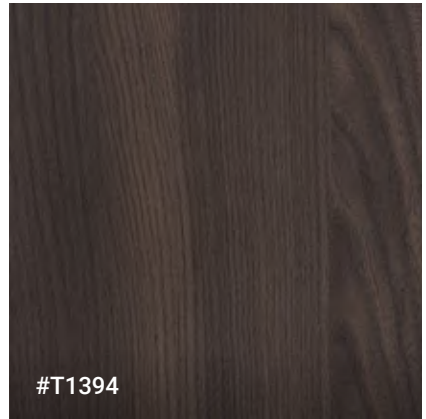

#T1394

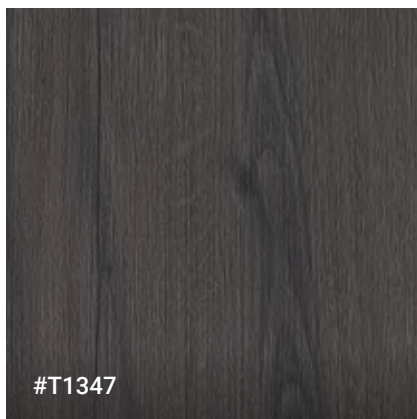

#T1347

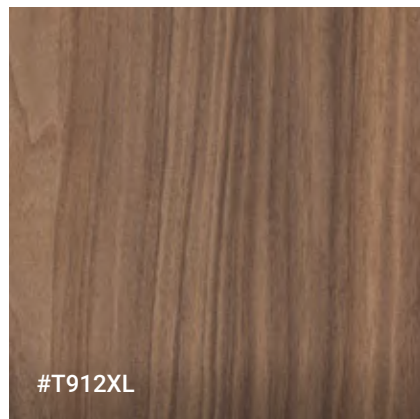

#T912XL



#C1429

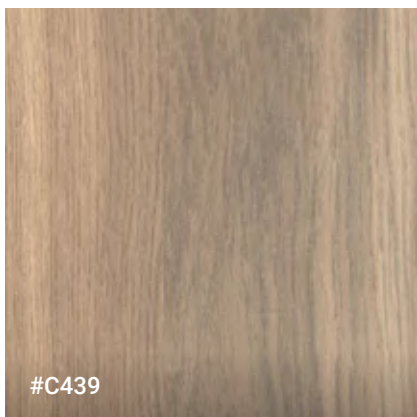
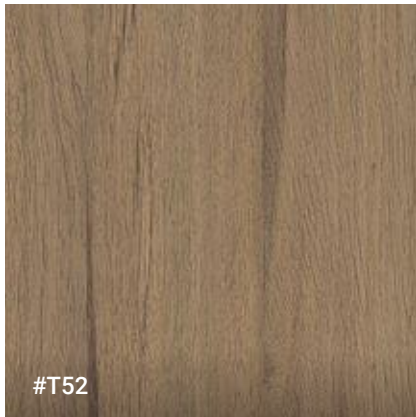
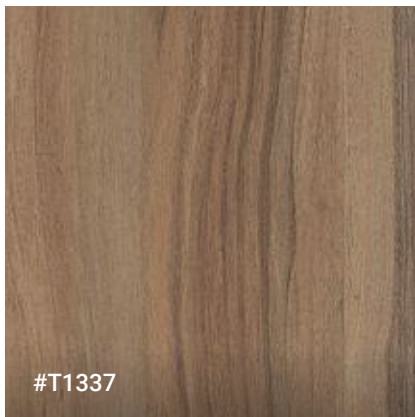
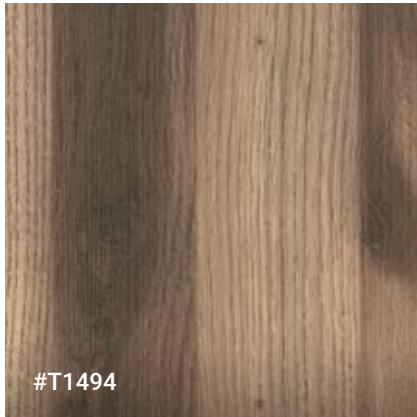
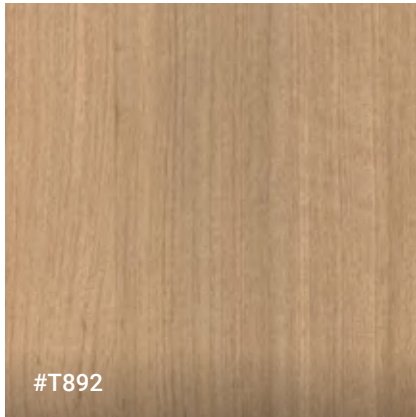

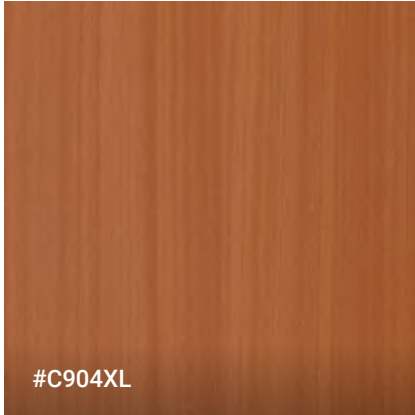

#C904XL



#C901XL

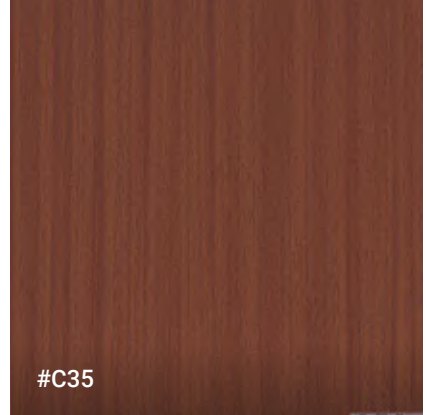

#C35

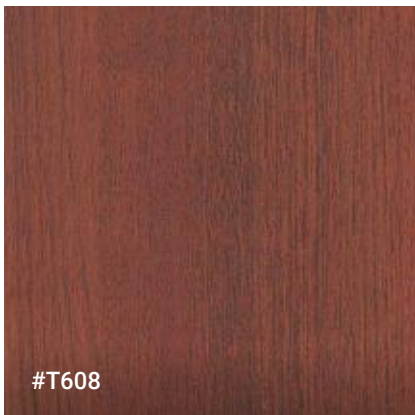

#T608

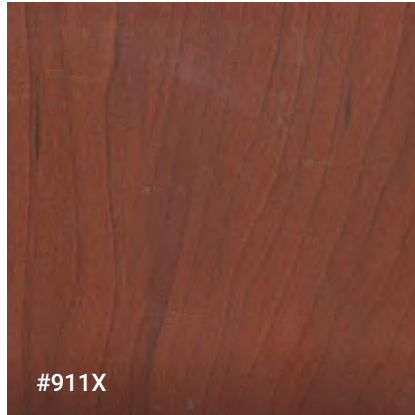

#911X



#T896XL



#T1407

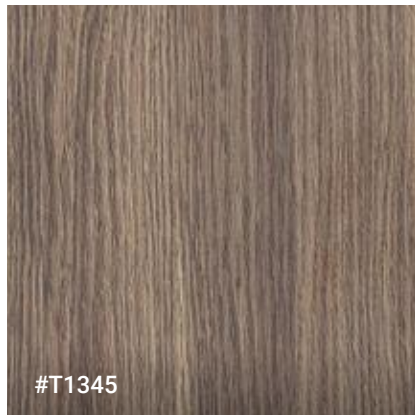

#T1345

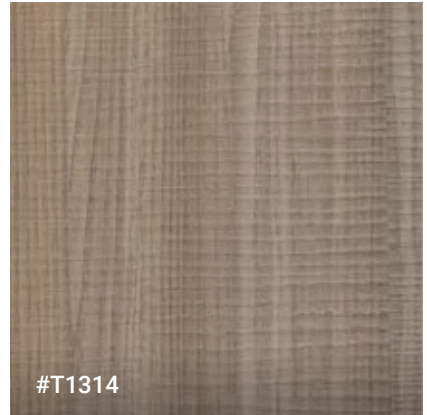

#T1314

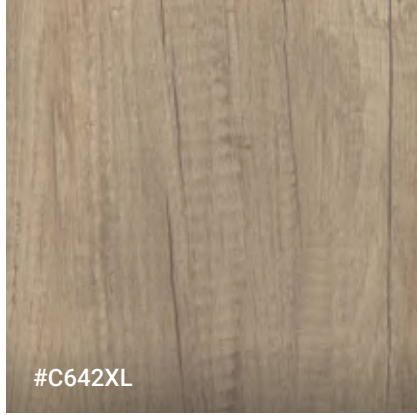

#C642XL

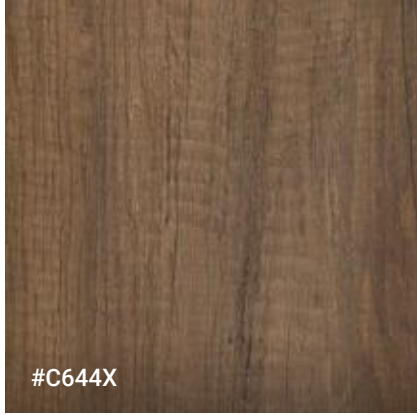

#C644X



#C639X



#T1431



#C640X



#C643X



#T1518

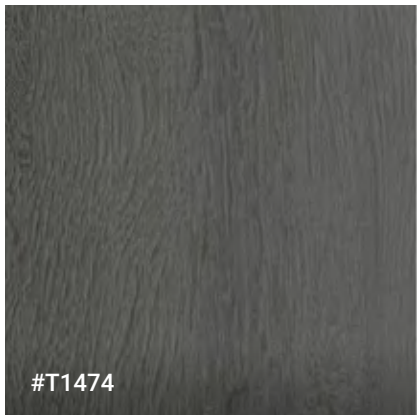

#T1474



#T1342

